

Fig. 2302A



Valve Standard :
Comply with API609

Pressure Temperature Ratings

Working pressure(Bar)	10/16/25
Testing Pressure(Bar)	Shell:15/24/37.5 Seal:11/17.6/27.5
Working Temperature(°C)	-10 to +85°C EPDM
Suitable Media	Drinking Water

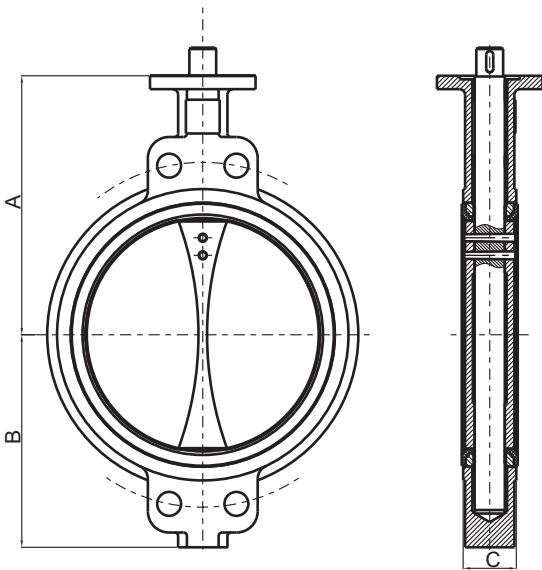

Material Specification

Part	Material	ASTM
Body	Ductile Iron	A536 Gr.65-45-12
Disc	Ductile Iron/ Stainless Steel	A536 Gr.65-45-12/ A351 CF-8M
Seat	EPDM	
O-rings	EPDM	
Shaft	Stainless Steel	A276 S410 00
Pin	Stainless Steel	A276 S316 00
Bushing	Bronze	B62 C83600
Cover	Ductile Iron	A536 Gr.65-45-12
Washer/Bolt	Stainless Steel	A276 S304 00

Dimensions

Size	mm	DN50	DN65	DN80	DN100	DN125	DN150	DN200	DN250	DN300	DN350	DN400	DN450	DN500	DN600
	inch	2	2-1/2	3	4	5	6	8	10	12	14	16	18	20	24
A	mm	161	175	181	200	213	226	260	292	337	368	400	422	480	562
	inch	6.34	6.89	7.13	7.87	8.39	8.90	10.24	11.50	13.27	14.49	15.75	16.61	18.90	22.13
B	mm	71.4	86	94	112.4	130	149.8	190	225	255	302	354	385	438	464
	inch	2.81	3.39	3.70	4.43	5.12	5.90	7.48	8.86	10.04	11.89	13.94	15.16	17.24	18.27
C	mm	42	44.5	44.5	51	54.5	54.5	59.6	67	75.5	75.5	102	114	130	151
	inch	1.65	1.75	1.75	2.01	2.15	2.15	2.35	2.64	2.97	2.97	4.02	4.49	5.12	5.94